

WM-4

LOWRANCE

SIMRAD

B&G



WM-4 Marine Weather & Audio Receiver

Installation Instructions

English (en-US)

Date: 08-2019

Copyright © 2019 Navico Holding AS.

Thank you for purchasing the WM-4 Marine Weather and Audio Receiver

Tracking of weather is easier than ever with the WM-4 Receiver for Simrad, Lowrance, and B&G multifunction displays. The WM-4 provides live, up-to-date weather information and forecasting to give you peace of mind, no matter when or how you are using your boat. The weather information is obtained from the weather industry's leading experts and is delivered via a digital receiver through SiriusXM's Marine Weather services.

Receive high-quality and comprehensive weather information and forecasting that you can overlay directly onto your raster and vector charts. The WM-4 brings you premium weather content, such as current weather reports, NOWRad® nationwide high-resolution weather radar imagery, and high-resolution Sea Surface Temperature images that can help fishermen locate fishing hot spots. Hardware and the SiriusXM weather service subscription are sold separately.

The WM-4 Receiver also provides access to over 150* channels of SiriusXM satellite radio service which can be added at a discounted rate to the Marine subscription. For more information about SiriusXM Marine service features and pricing in the US visit siriusxm.com/marine and in Canada visit siriusxm.ca/marine.

*Canadian SiriusXM satellite radio subscribers will have access to over 130 channels at a discounted rate with the marine subscription.

Fair Use Statement

You may print no more than three copies of this manual for your own use. You may not make any further copies or distribute or use the manual in any other way including without limitation exploiting the manual commercially or giving or selling copies to third parties.

Product Handbooks

The latest versions of manuals are available to download at the Simrad, Lowrance, and B&G websites.

Simrad: <https://www.simrad-yachting.com/help--support/>

Lowrance: <https://www.lowrance.com/help-and-support/>

B&G: <https://www.bandg.com/help--support/>

Safety Notices



Warning: Product installation and operation

This product must be installed and operated in accordance with the instructions provided. Failure to do so could result in personal injury, damage to your vessel and/or poor product performance.



Warning: Maintain a permanent watch

Always maintain a permanent watch, this will allow you to respond to situations as they develop. Failure to maintain a permanent watch puts yourself, your vessel and others at serious risk of harm.



Warning: Potential ignition source

This product is NOT approved for use in hazardous/flammable atmospheres. Do NOT install in a hazardous/flammable atmosphere (such as in an engine room or near fuel tanks).

Caution: Power supply protection

When installing this product ensure the power source is adequately protected by means of a suitably-rated fuse or automatic circuit breaker.



Warning: Switch off power supply

Ensure the vessel's power supply is switched OFF before starting to install this product. Do NOT connect or disconnect equipment with the power switched on, unless instructed in this document.



Warning: Product grounding

Before applying power to this product, ensure it has been correctly grounded, in accordance with the instructions in this guide.



Warning: Positive ground systems

Do not connect this unit to a system which has positive grounding.

Caution: Service and maintenance

This product contains no user serviceable components. Please refer all maintenance and repair to authorized Navico dealers. Unauthorized repair may affect your warranty.

General Information

EMC Installation Guidelines

Simrad, Lowrance, and B&G equipment and accessories conform to the appropriate Electromagnetic Compatibility (EMC) regulations, to minimize electromagnetic interference between equipment and minimize the effect such interference could have on the performance of your system. Correct installation is required to ensure that EMC performance is not compromised.

For optimum EMC performance we recommend that wherever possible:

- Simrad, Lowrance, and B&G equipment and cables connected to it are:
 - At least 1 m (3 ft) from any equipment transmitting or cables carrying radio signals e.g. VHF radios, cables and antennas. In the case of SSB radios, the distance should be increased to 7 ft (2 m).
 - More than 2 m (7 ft) from the path of a radar beam. A radar beam can normally be assumed to spread 20 degrees above and below the radiating element.
- The product is supplied from a separate battery from that used for engine start. This is important to prevent erratic behavior and data loss which can occur if the engine start does not have a separate battery.

- Simrad, Lowrance, and B&G specified cables are used.
- Cables are not cut or extended, unless doing so is detailed in the installation manual.

Note: Where constraints on the installation prevent any of the above recommendations, always ensure the maximum possible separation between different items of electrical equipment, to provide the best conditions for EMC performance throughout the installation.

Water Ingress

Water ingress disclaimer:

Although the waterproof rating capacity of this product meets the IPX6 & IPX7 standard, water intrusion and subsequent equipment failure may occur if the product is subjected to commercial high-pressure washing. Simrad, Lowrance, and B&G will not warrant products subjected to high-pressure washing.

Suppression Ferrites

Simrad, Lowrance, and B&G cables may be fitted with suppression ferrites. These are important for correct EMC performance. If a ferrite has to be removed for any purpose (e.g. installation or maintenance), it must be replaced in the original position before the product is used.

Connections to Other Equipment

Requirement for ferrites on non-Simrad, Lowrance, and B&G cables. If your Simrad, Lowrance, and B&G equipment is to be connected to other equipment using a cable not supplied by Simrad, Lowrance, and B&G, a suppression ferrite MUST always be attached to the cable near the Simrad, Lowrance, and B&G unit.

Product disposal

Dispose of this product in accordance with the WEEE Directive.



■ The Waste Electrical and Electronic Equipment (WEEE) Directive requires the recycling of waste electrical and electronic equipment. Whilst the WEEE Directive does not apply to some Simrad, Lowrance, and B&G products, we support its policy and ask you to be aware of how to dispose of this product.

IMO and SOLAS

The equipment described within this document is intended for use on leisure marine boats and workboats not covered by International Maritime Organization (IMO) and Safety of Life at Sea (SOLAS) Carriage Regulations.

Technical Accuracy

To the best of our knowledge, the information in this document was correct at the time it was produced. However, Simrad, Lowrance, and B&G cannot accept liability for any inaccuracies or omissions it may contain. In addition, our policy of continuous product improvement may change specifications without notice. As a result, Simrad, Lowrance, and B&G cannot accept liability for any differences between the product and this document. Please check the Simrad, Lowrance, or B&G website to ensure you have the most up-to-date version(s) of the documentation for your product.

Simrad: <https://www.simrad-yachting.com/help--support/>

Lowrance: <https://www.lowrance.com/help-and-support/>

B&G: <https://www.bandg.com/help--support/>

Parts Supplied

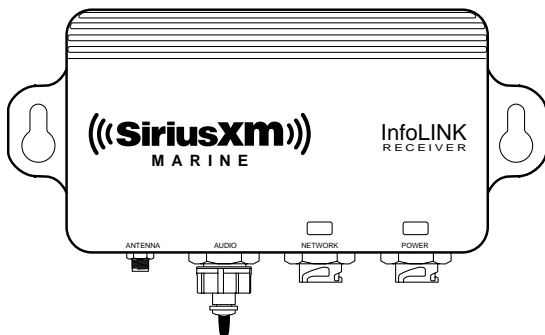

WM-4 Marine Weather and Audio Receiver

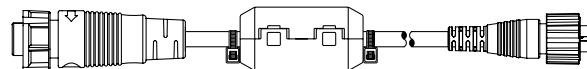

WM-4 Network Cable, Item #: 000-14972-001

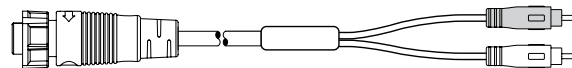

WM-4 Stereo Audio Cable, Item #: 000-14973-001

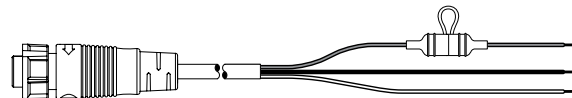

WM-4 Power Cable, Item #: 000-14971-001

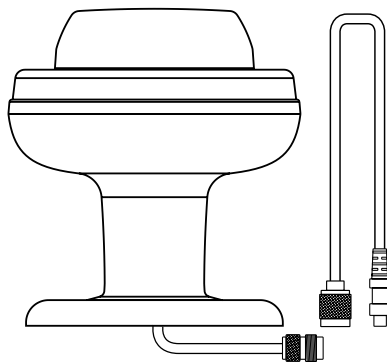

Shakespeare® SRA-50 Antenna
(Includes 25' Cable & Mounting Accessories)

Item #: 000-1494-001

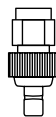

SMA to SMB Adapter

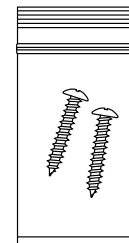

Mounting Screws (2)

Multifunction display hardware and software compatibility and software updates

For compatibility information and to download the latest software updates visit our websites:

- www.simrad-yachting.com
- www.lowrance.com
- www.bandg.com

Installation Overview

Shown at right is a typical installation overview for the WM-4 Receiver.

The WM-4 Receiver can be connected directly to a Multifunction Display, or to a Network Expansion Port.

The audio connection is optional and is used if you subscribe to a SiriusXM music and entertainment package in addition to the SiriusXM Marine subscription package.

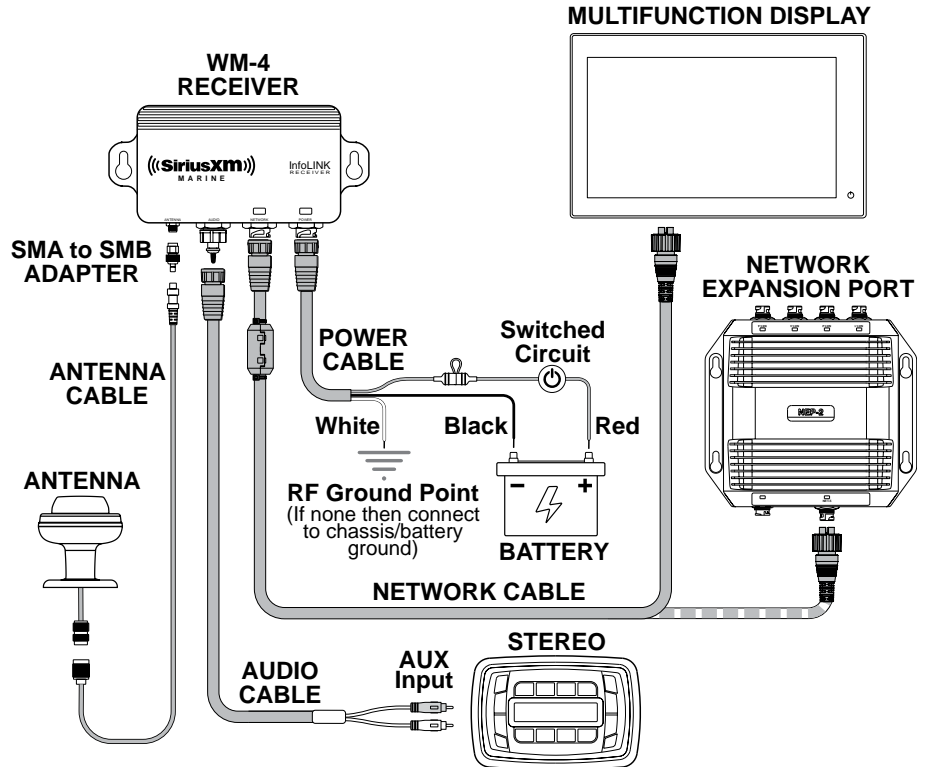

Required Additional Components

Component / Service	Required for SiriusXM Satellite Radio	Required for SiriusXM Marine Weather
Sirius SRA-50 type-approved antenna	✓	✓
Compatible Lowrance, Simrad and B&G multifunction displays	✓	✓
GPS receiver — provides position information for your vessel in the weather, chart and radar applications. Some multifunction displays have an internal GPS receiver. If your display does not have an internal GPS, an external GPS receiver will be required.	✗	✓
Third-party external audio system — required if you want to listen to SiriusXM satellite radio.	✓	✗
SiriusXM marine weather subscription	✗	✓
SiriusXM satellite radio subscription	✓	✗

Cable Identification

The following is the pin identification for the Network Cable provided with the WM-4 Receiver.

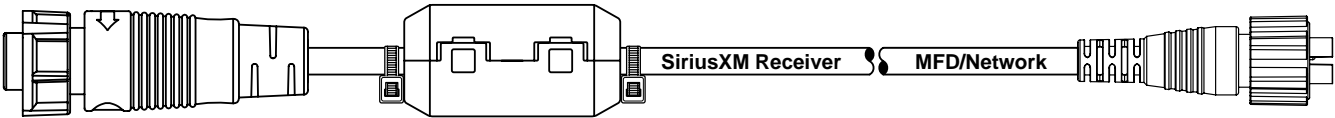

Item #: 000-14972-001

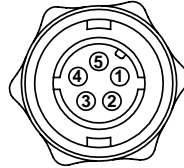
SiriusXM Connector	Pin	Description	Network Connector	Pin	Description
	1	Ethernet RX+ (White/Green)		1	Ethernet TX+
	2	Ethernet RX- (Green)		2	Ethernet TX-
	3	Ethernet TX+(White/Orange)		3	Ethernet RX+
	4	Ethernet TX- (Orange)		4	Ethernet RX-
	5	HW ID-A		5	Shield/Ground
	6	HW ID-B			
	7	Shield/Ground			

Note: if a longer network connection is needed, visit www.lowrance.com, www.simrad-yachting.com, or www.bandg.com for additional extension solutions.

The following is the pin and wire identification for the Power Cable provided with the WM-4 Receiver.

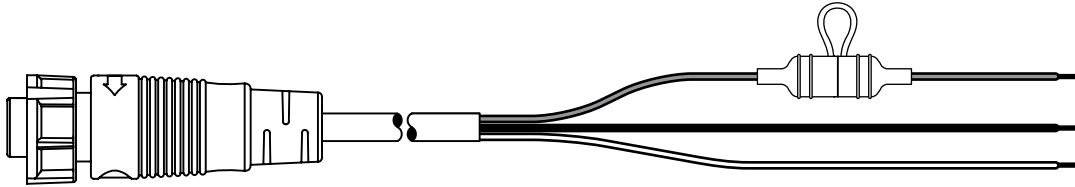

Item #: 000-14971-001

Power Connector	Pin	Description	Wire Color	Description
	1	Battery + (Switched)	Red	Battery + (Switched)
	2	Ground -	Black	Ground -
	3	RF Shield Ground	White	RF Shield Ground

The following is the pin and connector identification for the Audio Cable provided with the WM-4 Receiver.

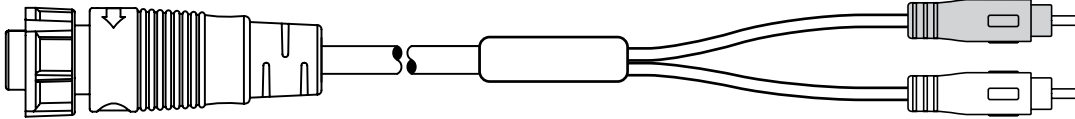

Item #: 000-14973-001

Audio Connector	Pin	Description	Connector Color	Description
	1	Left Audio +	Red	Right Stereo Audio
	2	Left Audio -		
	3	Right Audio -	White	Left Stereo Audio
	4	Right Audio +		

WM-4 Receiver Installation

Select a mounting location for the WM-4 Receiver that is sheltered from the elements. While the receiver is water resistant, it should be mounted where there will be no direct contact with water, or water spray, if possible.

Also consider the proximity for the several cables which will be need to be connected, antenna, power, data, and optionally audio, so that the cables reach.

Before mounting the unit, make a note of the Electronic Serial Number on the underside of the unit.

Once you have determined a suitable location, attach the receiver using the two provided screws.

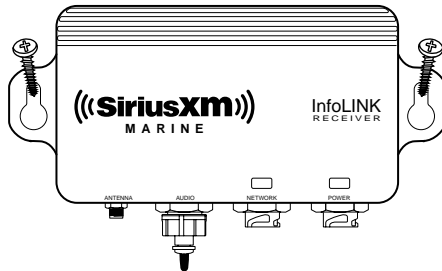

Connect the Power Cable

The WM-4 Receiver should be connected to a 12 or 24 volt power source, negative ground.

Caution: Some vessels may have a positive ground system. DO NOT connect to positive ground system.

Be sure the vessels' power is off before making the power connection, or the fuse or circuit breaker which will be powering the WM-4 Receiver is off.

Power Wire	Connection (See diagram on page 7)
Red	12v or 24v positive power (switched on/off with vessel's main power)
Black	Ground (negative)
White	The RF shield wire. Ground this wire to the vessel's dedicated grounding system. For vessels without a dedicated grounding system, connect to chassis/battery ground.

Power Cable Extension

The product is supplied with a power cable, which can be extended if required.

The following restrictions apply to any extension to the power cable:

- Cable must be of a suitable gauge for the circuit load.

- Each unit should have its own dedicated power cable wired back to the distribution panel.

Total Length (max)	Supply Voltage	Cable Gauge (AWG)
0-5 m (0-16.4 ft)	12 V	18
	24V	20
5-10 m (16.4-32.8 ft)	12 V	14
	24V	18
10-15 m (32.8-49.2 ft)	12 V	12
	24V	16
15-20 m (49.2-65.5 ft)	12 V	12
	24V	14

Note: These distances are for a 2-wire power cable run from the battery to the product (approximate distance). To calculate the round trip length, double the figure stated here.

Breakers, Fuses and Circuit Protection

It is recommended that you fit a thermal breaker or fuse at the distribution panel.

- Thermal breaker rating: 5 A (if only connecting one device)

Note: The suitable fuse rating for the thermal breaker is dependent on the number of devices you

are connecting. If in doubt consult an authorized Lowrance, Simrad, or B&G dealer.

Connect the Power Cable to the **POWER** connection of the receiver.

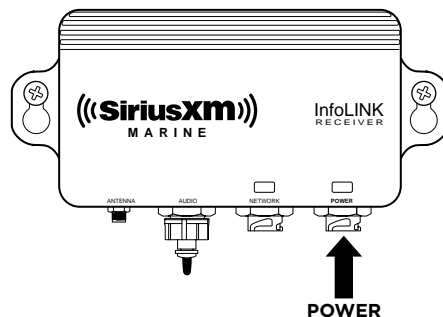

Connect the Network Cable

The Network Cable should be connected to your system. The cable is marked near each end to distinguish the connectors.

If your system does not utilize a Network Expansion Port, connect the cable to the MFD's Network port.

If your Navico system utilizes a Network Expansion Port, connect the cable to the Network Expansion Port. If there are no available connections on the existing Network Expansion Port, you will need to purchase another Network Expansion Port to accommodate the WM-4 Receiver.

Connect the 7-pin end of the cable to the **NETWORK** connection of the WM-4 Receiver.

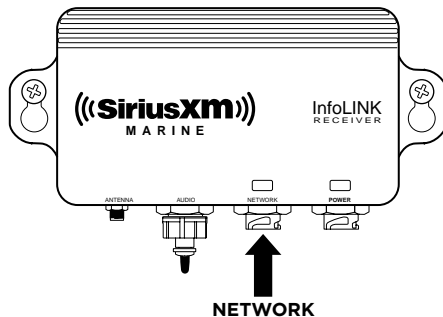

Connect the Audio Cable (optional)

The audio connection is optional and is used if you subscribe to a SiriusXM music and entertainment package in addition to the SiriusXM Marine subscription package.

If you are not installing an audio connection, do not remove the water resistant cap that is installed on the WM-4 Receiver's **AUDIO** connector.

The Audio Cable provides an RCA-style Left and Right audio connection. Connect these to the auxiliary (AUX) input on your audio device.

If your audio system does not have RCA connectors they will need an adapter cable, available from the local dealer or an electronics retailer.

Remove the water resistant cap that is installed on the WM-4 Receiver's **AUDIO** connector, and connect the Audio Cable.

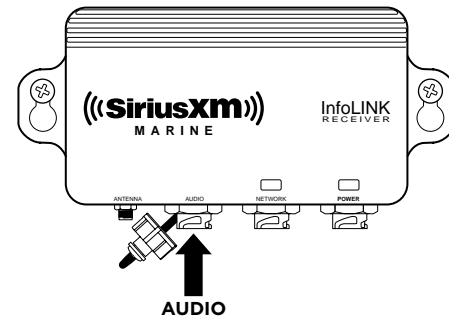

Antenna Installation

Caution: When installing the antenna, do not cut or alter the antenna cable, or remove the cable connectors.

Two considerations are necessary before installing the antenna. First, finding a suitable mounting location, and second determine how the antenna will be mounted. There are several in-box mounting options for the antenna, or accessories can be purchased from marine stores for additional mounting options.

In choosing where to mount the antenna, consider whether you will be securing the antenna from the underside of the mounting surface, or attaching the antenna to the mounting surface. Also, determine if the antenna wire will be passed through the mounting surface, or if it will be routed along the surface.

If the distance between the antenna and the WM-4 Receiver is more than 25 feet, special cable kits are available. Plan and purchase the appropriate kit before proceeding (page 16).

Choose a Location

The antenna must be mounted horizontally, and in a location that is open and has a clear view of the sky.

The antenna must also be mounted away from any metal objects or other structures that could block the line-of-sight reception of the satellite signal. The height of the antenna is not as important as having a clear view of the sky.

The antenna should be mounted a minimum of 1 m (3 ft.) away from other radio transmitting antennas (such as VHF or Sideband antennas), and a minimum of 2 m (7 ft.) from a radar antenna.

Once you have selected a possible mounting location, sight a full 360° circle around the antenna at an elevation angle of 25° to make sure no obstacles block the antenna's view of the sky.

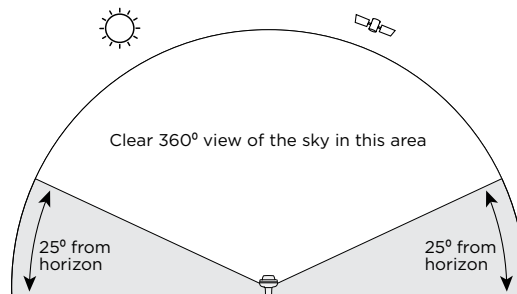
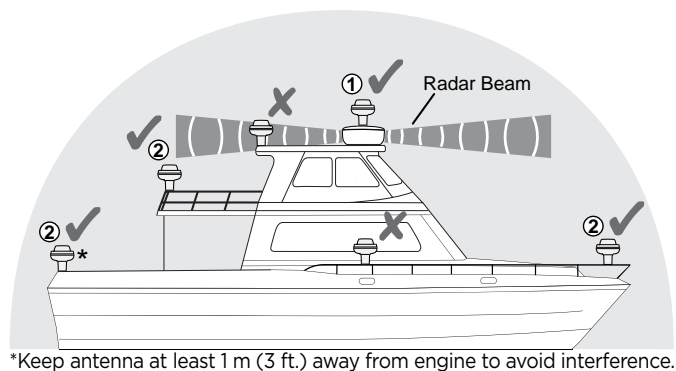

Choose a Mounting Option

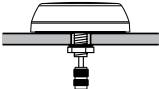
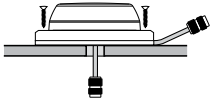
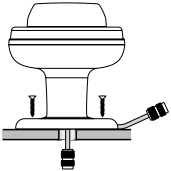
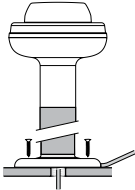
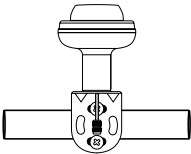
In-Box Mounting Options		
Surface Mount		<p>Antenna secured from the underside of the mounting surface. For mounting surfaces between 1/4" and 1" thick, use the supplied extension shaft. Route antenna cable through the mounting surface. Secure from below mounting surface using the mounting lock washer & retaining nut.</p>
Low Profile Surface Mount		<p>Antenna secured topside to the mounting surface, and also used when the antenna cable cannot be routed through the mounting surface to the underside. Secure to the surface using 4 screws.</p>
Pedestal Mount		<p>Antenna secured topside above the mounting surface. Route antenna cable either through or above the mounting surface. Secure to the surface using 3 screws.</p>
Optional Mounting Options (purchased separately)		
Extension Mast Mount		<p>Extension masts can be purchased in varying lengths to extend the antenna up a greater distance above the mounting surface. Antenna secured topside to the mounting surface. Route antenna cable either through or above the mounting surface. Secure to the surface using 3 screws.</p>
Rail Mount (Shakespeare model 4720 Rail Mount)		<p>Use to attach the antenna to an existing 7/8", 1", or 1-1/4" rail on the vessel.</p>

Installing the Antenna

In-box antenna mounting options are surface mount, low-profile surface mount, or pedestal mount. Optional mounting options such as an extension mast or Rail Mount are available.

Always mount the antenna so that it does not interfere with safe operation of the vessel.

Important: When mounting to a surface using the low-profile, pedestal, or extension mast mounting method where the antenna cable will exit above the mounting surface, orient the base or pedestal bottom so that the antenna cable exits towards the rear of the vessel, away from oncoming wind from normal vessel motion.

The following accessories are available:

- WM-4 SIRIUS SAT WEATHER POWER CABLE
- WM-4 SIRIUS SAT WEATHER ETHERNET ADAPTER
- WM-4 SIRIUS SAT WEATHER RADIO CABLE
- WM-4 SIRIUS SAT WEATHER INSTALL KIT
- WM-4 SIRIUS SAT WEATHER ANTENNA EXT

Follow the instructions in the next sections for the mounting method you've selected. **Do not cut the 6" antenna lead or remove the connectors from any of the cables under any circumstances.**

Surface Mount

1. Drill a 9/16" mounting hole. When drilling fiberglass surfaces, use a small backup block of scrap wood underneath to control push-through splintering. Use caution to avoid drilling through or near fuel lines, fuel tanks, hydraulic lines, or electrical wiring.

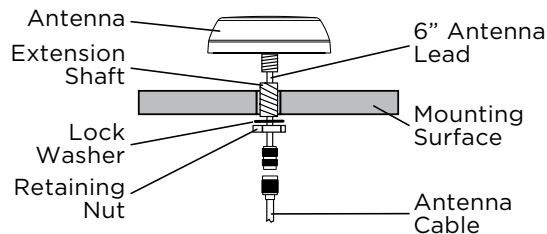

2. For mounting surfaces greater than 1/4" thick (up to 1" thick), use the extension shaft (provided), otherwise continue with step 3.
 - a. Route the 6" antenna lead with TNC female connector through the center of the extension shaft.
 - b. Thread the extension shaft onto the existing antenna shaft and tighten.
3. Pass the 6" antenna lead connector and cable, and extension shaft (if used), through the hole

that was drilled.

4. Apply a small bead of marine sealant around the outer edge of the antenna base to insure a watertight seal.
5. Secure the antenna to the mounting surface with the supplied retaining nut and lock washer.
6. Connect the antenna cable to the 6" antenna lead.
7. Route the antenna cable to the WM-4 Receiver and connect the antenna cable to the SMA to SMB Adapter. Connect the adapter to the **Antenna** connection of the WM-4 Receiver.

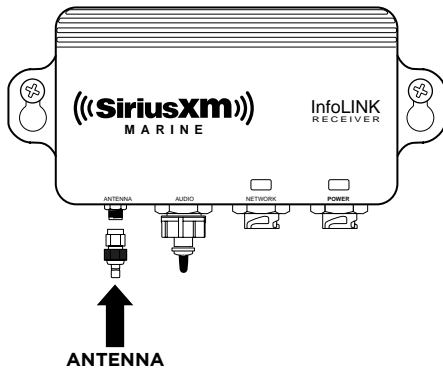

Low Profile Surface Mount

1. If you are going to route the antenna cable through the mounting surface, drill a 9/16"

center hole for the antenna cable. When drilling fiberglass surfaces, use a small backup block of scrap wood to control push-through splintering. Use caution to avoid drilling through or near fuel lines, fuel tanks, hydraulic lines, or electrical wiring.

2. Attach the antenna onto the base by using the lock washer and retaining nut.
3. Orient the antenna as desired. Place on the mounting surface and take off the antenna

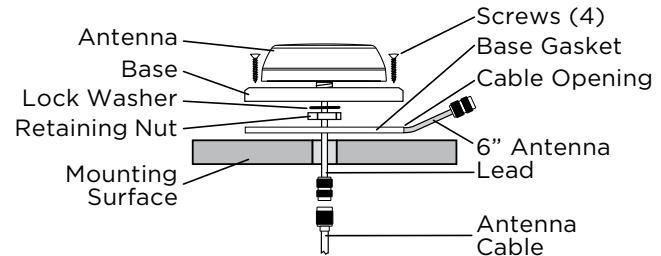

and base leaving the base gasket in the same position. Use the base gasket as a template to mark the locations for screws.

4. The provided mounting screws will accommodate most surfaces. If you find them too long, too short, or otherwise unsuitable for your application, substitute wood screws, machine screws/washers/nuts, or other hardware (not provided). Be sure to use only stainless steel hardware. If you find it too difficult to start the mounting screws, drill 3 mm (7/64") pilot holes.

5. Either pass the 6" antenna lead along with the connector through the center hole, or, lay the 6" antenna lead into the cable opening in the base gasket. Place the antenna, base, and base gasket on the mounting surface aligning it to the marks made in step 3.
6. Use the provided mounting screws (or other stainless steel hardware, not provided) to mount the antenna to the surface. Do not over-tighten the screws.
7. Connect the antenna cable to the 6" antenna lead.
8. Route the antenna cable to the WM-4 Receiver and connect the antenna cable to the SMA to SMB Adapter. Connect the adapter to the **Antenna** connection of the WM-4 Receiver.

Pedestal Mount

1. If you are going to route the antenna cable through the mounting surface, drill a 9/16" mounting hole. When drilling fiberglass surfaces, use a small backup block of scrap wood to control push-through splintering. Use caution to avoid drilling through or near fuel lines, fuel tanks, hydraulic lines, or electrical wiring.
2. Assemble the antenna as shown:
 - a. Attach the antenna to the base with the lock washer and retaining nut.
 - b. Align the base with the antenna, the base

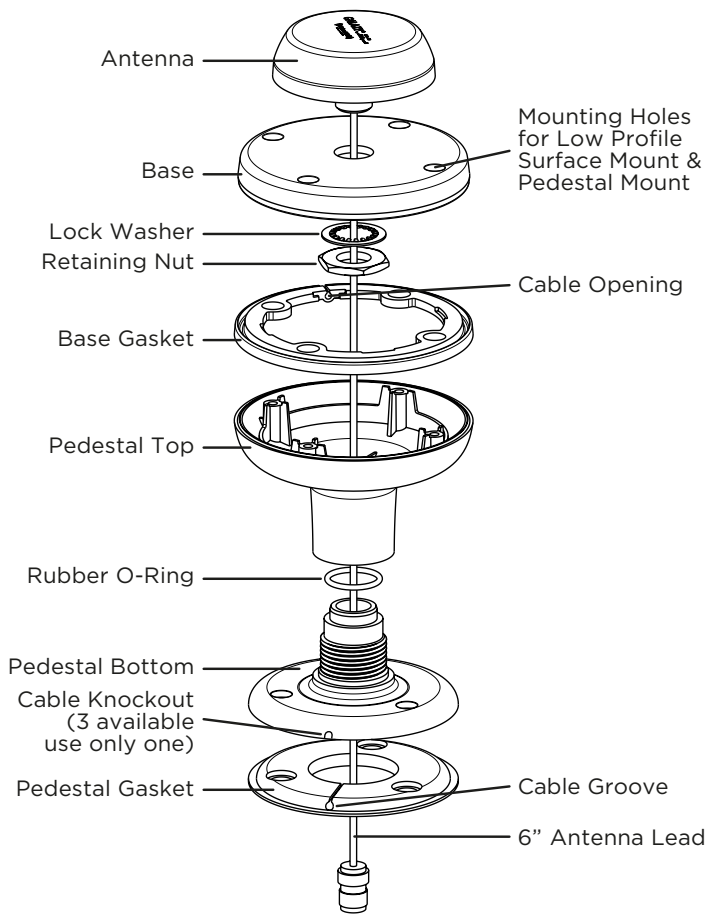

- gasket, and the pedestal top so that the openings for the 4 screws are aligned, and use the provided screws to screw them together.
- c. Place the rubber o-ring between the pedestal top and the pedestal bottom, and screw the pedestal bottom into the pedestal top.
 - d. Place the pedestal gasket into the pedestal bottom, aligning the screw holes.
3. Orient the antenna as desired and mark a pencil line on the pedestal bottom and on the mounting surface to serve as an alignment index later.
 4. While holding the pedestal gasket to the mounting surface, lift off the remainder of the antenna assembly and use the pedestal gasket as a template to mark the locations for the screws.
 5. The provided mounting screws will accommodate most surfaces. If you find them too long, too short, or otherwise unsuitable for your application, substitute wood screws, machine screws/washers/nuts, or other hardware (not provided). Be sure to use only stainless steel hardware. If you find it too difficult to start the screws, drill 7/64" pilot holes.
 6. Unscrew the pedestal bottom from the rest of the antenna assembly, keeping the rubber o-ring in place.
 7. If you are ***not*** routing the 6" antenna lead out through the side of the pedestal bottom, continue with step 9.

A needle nose pliers may be used to break off one of the three cable knockouts in the pedestal bottom to align with the cable groove in the pedestal gasket. Refer to the alignment mark made in step 3 to ensure the antenna cable exits the pedestal in the correct direction.
 8. Place the 6" antenna lead into the cable groove in the pedestal gasket and align with the cable knockout in the pedestal bottom.
 9. Attach the pedestal bottom and pedestal gasket to the mounting surface, orienting them according to the alignment mark made in step 3. Use the provided mounting screws (or other stainless steel hardware, not provided) to mount the pedestal to the surface. If you are routing the 6" antenna lead out through the side of the pedestal bottom, do not fully tighten the screws yet -- the 6" antenna lead must be free to turn. If the 6" antenna lead is routing through the mounting surface, route it through the mounting surface and tighten the screws. Do not over-tighten.
 10. Verify that the rubber o-ring is in place and attach the rest of the antenna assembly to the mounted pedestal bottom by screwing it onto the pedestal bottom until tight.

Note: If you are routing the 6" antenna lead out through the side of the pedestal bottom,

make sure the antenna lead can turn freely so that it does not get twisted as you screw the antenna assembly onto the pedestal bottom. When complete, finish tightening the 3 screws that hold the pedestal base to the mounting surface. Do not over tighten.

- 11.** Connect the antenna cable to the 6" antenna lead.
- 12.** Route the antenna cable to the WM-4 Receiver and connect the antenna cable to the SMA to SMB Adapter. Connect the adapter to the **Antenna** connection of the WM-4 Receiver.

Extension Mast Mount

- 1.** Follow the installation steps 2a and 2b in the Pedestal Mount section, Place the rubber o-ring over the threads of the extension mast.
- 2.** You will need to feed the 25' antenna cable through the pedestal gasket and pedestal bottom, and through the extension mast, and connect it to the 6" antenna lead. Screw down the assembled antenna into the extension mast.
- 3.** Route the antenna cable to the WM-4 Receiver and connect the antenna cable to the SMA to SMB Adapter. Connect the adapter to the **Antenna** connection of the WM-4 Receiver.

Rail Mount

The center hole in ratchet-type antenna mounts will not accommodate the connector. You must use an

optional rail mount which will allow the cable and its connector to pass through.

Do not cut the antenna cable and do not remove the connector in an attempt to accommodate a ratchet-type antenna mount.

- 1.** Follow installation steps 2a and 2b for the Pedestal Mount.
- 2.** Place the rubber o-ring over the threads of the rail mount and route the 6" antenna lead through the rail mount.
- 3.** Attach the antenna assembly to the rail mount by screwing it onto the rail mount until tight.
- 4.** Follow the instructions included with the rail mount for attaching the rail mount to a rail.
- 5.** Connect the antenna cable to the 6" antenna lead.
- 6.** Route the antenna cable to the WM-4 Receiver and connect the antenna cable to the SMA to SMB Adapter. Connect the adapter to the **Antenna** connection of the WM-4 Receiver.

Verify Operation

Power on the system, and the WM-4 Receiver. Verify that the Power LED light is on (blue), and that the Network LED light is randomly flashing green, which indicates normal network traffic.

Consult “Troubleshooting” on page 22 if the indicator LED lights are not on, or if the Network LED light is showing a blinking pattern.

Subscribe to SiriusXM Services

You can subscribe to the SiriusXM Marine service and add satellite Radio at a discount by following these steps:

1. Make sure the system is turned on. Verify that you are receiving the SiriusXM signal by entering the SiriusXM menu in your MFD.
2. Make a note of the Radio ID. You can find it on a label on the WM-4 Receiver packaging and on the label on the underside of the WM-4 Receiver.

NOTE! The Radio ID does not use the letters I, O, S, or F.

3. Activate your service:

In the USA:

First see our Customer Agreement for complete terms at www.siriusxm.com/marine and then:

- Online: Go to **www.siriusxm.com/activate**

OR

- By phone: **1-855-SXM-WTHR (1-855-796-9847)**

In Canada:

First see our Customer Agreement for complete terms at www.siriusxm.ca/marine and then:

- Online: Go to **www.siriusxm.ca/activate**

OR

- By phone: **1-844-823-0843**

4. Activation usually takes 10 to 15 minutes, but may take up to an hour. We recommend that your MFD remain on until subscribed.
5. Activation signals can be sent again at any time by visiting **www.siriusxm.com/refresh** (in USA) or **www.siriusxm.ca/refresh** (in Canada).

Troubleshooting

The troubleshooting information in this section is for general reference. Consult the documentation that accompanied your system for specific operating instructions and advisory messages that may be displayed.

LED Indicator Lights

The WM-4 Receiver has two LED indicator lights which show the current state of the receiver.

Power LED (Blue)	Network LED (Red/Amber/Blink)	Status
Off	Off	No Power. Turn power on or check power source/cable connection.
On	Amber, random blinking pattern	Normal network communication is established between the MFD and the WM-4 Receiver. Blinking amber indicates network traffic.
On	Red, 1-blink fast pattern	Network Cable is not connected, or not secured. Make sure the cable is connected and secured to the WM-4 Receiver.
On	Red, 1-blink slow pattern	Network cable connected is damaged or out of spec. Contact Lowrance, Simrad, or B&G for a replacement cable.
On	Amber, 2-blink pattern for 18 seconds	WM-4 Receiver has lost the link connection to the MFD or network expansion port. Please check the network components.
On	Red, 2-blink pattern	Network Cable is not connected to the MFD or Network Expansion Port. Confirm that the cable is connected to an MFD or Network Expansion Port. If the cable is properly connected to the MFD or Network Expansion Port, the cable may be damaged.
On	Red, 4-blink pattern	MFD is not communicating with the WM-4 Receiver. Check the MFD to determine the reason why the MFD is not communicating with the WM-4 Receiver.

MFD Message	Reason
No Signal (NoSignal)	Make sure that the vessel is outdoors with a clear view of the southern sky. Make sure the Antenna is mounted according to the instructions in this manual. Move your vessel away from any area which obstructs the antenna.
Check Antenna (Chek Antenna, CHK Antena, Chek Ant)	Make sure that the antenna cable is firmly and securely plugged into the WM-4 Receiver. Make sure the antenna cable is not bent or broken. Turn the MFD off, then on, to reset this message. If the message persists, most likely the antenna cable has been damaged. Replace the antenna.
Antenna Disconnected	Check the antenna connection to make sure it is fully plugged into the WM-4 Receiver.
Antenna Cable Shorted	Replace the antenna and antenna cable.
Check Tuner (Chek Tuner, Chk Tunr)	Network Cable is not connected to the MFD or network expansion port. Confirm that the cable is connected to an MFD or network expansion port.
Channel Not Available (Chan Unavailable, Ch Unavailable, Ch Unavail, Ch Unavl)	The channel you have selected is not available.

MFD Message	Reason
Channel Not Subscribed (CH Unsubscribed, Chan Unsub, Ch Unsub)	The channel you have selected is not part of your current subscription plan. First see our Customer Agreement for complete terms in the US at: www.siriusxm.com/marine and then call 1-855-796-9847 to subscribe, and in Canada at www.siriusxm.ca/marine and then call 1-844-823-0843 to subscribe.
Waiting To Establish Connection (Waiting to Connect)	The WM-4 Receiver is connected to the MFD network, but the MFD has not yet established a connection.

Customer support

For support, please obtain the following information using the product menus:

- Product name, Product identity, Serial number
- Software application version and System diagrams.

Visit the Web customer support area at:

www.lowrance.com/en-US/Support/service-support/

www.simrad-yachting.com/Support/Service-and-Support/

www.bandg.com/help--support/

Specifications

WM-4 Receiver

Dimensions	7 in (W) x 3.1 in (H) x 1.7 in (D) 180 mm (W) x 80 mm (H) x 42 mm (D)
Weight	9.63 oz (273 g)
Nominal Supply Voltage	12v or 24v DC
Operating Voltage Range	10.8v to 31.2v DC
Power Consumption	<3.0W
Operating Temperature	-4°F to +158°F (-20°C to +70°C)
Waterproof Rating	IPX 6/7
Antenna Connection	SMA (SMA to SMB adapter included)
Network Connection	TCP/IP over Ethernet (10/100-Base-TX) Static IP: 172.22.255.252 Gateway: 172.22.251.1 Subnet Mask: 255.255.255.0
Audio Connection	Stereo Analog Audio Out, 2v RMS
Power Connection	2-Wire Switched B+ and Ground, plus RF Ground

Antenna

Type	SiriusXM approved Marine Antenna
Pigtail Cable	.6 in (152 mm), TNC Female
Antenna Cable	.25 ft (7.6 m), TNC male to SMB

Cables

Network Cable Length	8 ft (2.5 m) 7-pin to RJ45
Waterproof Rating	Cable Connectors IPX 6/7
Power Cable Length	6.5 ft (2 m), Fuse 5.0 A, AGC
Waterproof Ratings	Cable Connector IPX 6/7, Fuse Holder IPX 5
Audio Cable Length	6.5 ft (2 m)
Waterproof Rating	IPX 6/7

Network Operation XM Network

Specifications are subject to change without notice.

FCC Statement

The user is cautioned that changes or modifications not expressly approved by Navico Inc. or Sirius XM Radio Inc. can void the user's authority to operate this device. This device complies with Part 15 of the FCC Rules. Operation is subject to the following two conditions:

1. This device may not cause harmful interference.
2. This device must accept any interference received, including interference that may cause undesired operation.

This equipment has been tested and found to comply with the limits for a Class B digital device, pursuant to Part 15 of the FCC Rules. These limits are designed to provide reasonable protection against harmful interference in a residential installation. This equipment generates, uses, and can radiate radio frequency energy and, if not installed and used in accordance with the installation instructions, may cause harmful interference to radio communications. However, there is no guarantee that interference will not occur in a particular installation. If this equipment does cause harmful interference to radio or television reception, which can be determined by turning the equipment off and on, the user is encouraged to try to correct the interference by one or more of the following measures:

- Reorient or relocate the receiving antenna of the affected receiver.
- Increase the separation between the Navico or SiriusXM equipment and the affected receiver.
- Connect the Navico or SiriusXM equipment into an outlet on a circuit different from that to which the affected receiver is connected.
- Consult the dealer or an experienced radio/TV technician for help.

IC Information

Warning: Changes or modifications not expressly approved by the manufacturer could void the user's authority to operate the equipment.

Canadian Compliance: This Class B digital apparatus complies with Canadian ICES-003.

IC STATEMENT

Operation is subject to the following two conditions: (1) this device may not cause interference, and (2) this device must accept any interference, including interference that may cause undesired operation of the device. For product available in the Canada market, only channel 1-11 can be operated. Selection of other channels is not possible. This device and its antenna(s) must not be co-located or operation in conjunction with any other antenna or transmitter. To reduce potential radio interference to other users, the antenna type and its gain should be so chosen that the equivalent isotropically radiated power (e.i.r.p) is not more than that permitted for successful communication. IC Radiation Exposure Statement: This equipment complies with IC RSS-102 radiation exposure limits set forth for an uncontrolled environment. This equipment should be installed and operated with minimum distance 20cm between the radiator & your body.

SiriusXM Patent Information

It is prohibited to, and you agree that you will not, copy, decompile, disassemble, reverse engineer, hack, manipulate, or otherwise access and/or make available any technology incorporated in this product. Furthermore, the AMBE® voice compression software included in this product is protected by intellectual property rights including patent rights, copyrights, and trade secrets of Digital Voice Systems, Inc. The software is licensed solely for use within this product. The music, talk, news, entertainment, data, and other content on the Services are protected by copyright and other intellectual property laws and all ownership rights remain with the respective content and data service providers. You are prohibited from any export of the content and/or data (or derivative thereof) except in compliance with applicable export laws, rules and regulations. The user of this or any other software contained in a SiriusXM radio is explicitly prohibited from attempting to copy, decompile, reverse engineer, hack, manipulate or disassemble the object code, or in any other way convert the object code into human-readable form.

Environmental Information

⚠ WARNING: Cancer and reproductive harm- www.P65Warnings.ca.gov.

Copyrights and Trademarks

Navico Legal Information

Navico® is a registered trademark of Navico Holding AS.

Lowrance® is a registered trademark of Navico Holding AS.

Simrad® is used by license from Kongsberg.

B&G® is a registered trademark of Navico Holding AS.

Shakespeare Legal Information

Shakespeare and related marks are property of Shakespeare Company, LLC. All Rights Reserved.

SiriusXM Legal Information

© 2019 Sirius XM Radio Inc. Sirius, SiriusXM, XM and all related marks and logos are trademarks of Sirius XM Radio Inc. All other trademarks, tradenames, or company names referenced herein used for identification only and are the property of their respective owners.

This product is protected by patents, design patents, patents pending, or design patents pending.

Important Legal Notice About Your SiriusXM Subscription

Hardware and subscription sold separately. **The subscription plan you choose will automatically renew and you will be charged according to your chosen payment method at then-current rates.** Fees and taxes apply. Please see our Customer Agreement, **for the US at www.siriusxm.com and for Canada at www.siriusxm.ca**, for complete terms and how to cancel, which includes calling SiriusXM **in the US at 1-800-985-9200 or in Canada at 1-844-823-0843**. All fees, content and features are subject to change. Our satellite service is available only to those at least 18 and older in the 48 contiguous USA, DC and Canada. Our Sirius satellite service is also available in PR (with coverage limitations) **but this Receiver is not operational in PR**. Our Internet radio service is available throughout our satellite service area and in AK and HI. Channel lineup varies by subscription package.

Important Legal Notice About Installation

Installation instructions are provided for your convenience. You must determine if you have the knowledge, skills, and ability required to properly perform installation. Professional installation is recommended. Navico shall have no liability for damage/injury resulting from the installation/use of any Navico products or services. You must ensure that all products are installed in adherence with local laws and regulations and in such a manner as to allow a vehicle to be operated safely and without distraction. Navico product warranties do not cover the installation, removal, or reinstallation of any product.

CAUTION! Always wear safety goggles, ear protection, and a dust mask when drilling, cutting, or sanding.

NOTICE! When drilling or cutting, always check what is on the opposite side of the surface.

LIMITED WARRANTY

NAVICO LIMITED WARRANTY for U.S.A. and CANADA

Navico Holdings AS (“Navico”) warrants that the **WM-4 InfoLINK™ SiriusXM Marine Weather & Audio Receiver**, when properly installed and used, will be free from defects in material and workmanship for one (1) year from the date of first purchase (the Warranty Period). For the purpose of this Warranty, ‘date of first purchase’ means the date the product was purchased by the first retail customer; or in the case of a product installed on a new vessel by a Certified/Approved Navico Boat Builder, the date the first retail customer took delivery of the vessel.

Navico will, at its sole discretion, repair or replace with new or refurbished parts or product, or equivalent product, any proven defective products or components returned to Navico, or its approved agent during the Warranty Period. Such repairs or replacements will be the sole remedy of the customer under this Warranty.

This warranty gives you specific legal rights, your rights may vary from jurisdiction to jurisdiction. These rights exist alongside all rights you have under local law.

OBTAINING WARRANTY SUPPORT

Customers can obtain warranty support by contacting:

- Their local Navico Certified/Approved Dealer or Distributor (a list of Certified/Approved Dealers and Distributors can be found on www.simrad-yachting.com, www.lowrance.com, www.bandg.com, www.GoFreeMarine.com).
- Navico, Americas on 1 800 628 4487

EXTENDED WARRANTIES

Extensions to the Product Warranty period and On Board Support period are available for purchase. Contact Navico for further details.

PRODUCT MANUALS

Product Manuals for the **WM-4 InfoLINK™ SiriusXM Marine Weather & Audio Receiver** are available for download at www.simrad-yachting.com, www.lowrance.com, www.bandg.com, www.GoFreeMarine.com.

LOWRANCE®

SIMRAD

B&G